

Car Cabin Air Quality Sensors and Systems

Kosmas Galatsis¹, Wojtek Wlodarski²

¹Microelectronics Advanced Research Corporation (MARCO), Center on Functional Engineered Nano Architectonics (FENA), University of California, Los Angeles, CA, USA

²School of Electrical and Computer Systems Engineering, Royal Melbourne Institute of Technology University, Melbourne, VIC, Australia

CONTENTS

1. Introduction
 2. Vehicle Cabin Air Quality Monitoring (AQM)
 3. Vehicle Cabin AQM Gas Sensors
 4. Future AQM Research and Development
 5. Conclusions
- Glossary
References

1. INTRODUCTION

It is not surprising that air quality in vehicle cabins is usually found to be worse than that typically found in homes or workplaces, especially when so many exhaust pipes are only inches away from adjacent vehicles. Pollutants find their way into the cabin via the ventilation system, also known as the Heating, Ventilation and Air Conditioning (HVAC) system. Independent studies [1–3] have shown that vehicle cabins commonly show concentrations of toxic gases such as carbon monoxide (CO), hydrocarbons (HC), volatile organic compounds (VOC), and oxides of nitrogen (NO_x) higher than safety limits set by Occupational Safety and Health Administration (OSHA) and World Health Organization (WHO).

As experienced by most, discomfort due to offensive smells is the prime concern regarding pollutants in vehicle cabins. However, more serious are the adverse health effects that result. The most dangerous is fatigue. Driver fatigue is a primary concern in the battle to decrease road fatalities. A media announcement from the Department of Transport in Australia, states that fatigue is the principal cause for 20% of crashes involving a fatality [4]. Fatigue is often associated with feelings of drowsiness or sleepiness, loss of alertness, inability to concentrate, and slowed reactions. Aside from

lack of sleep, fatigue symptoms can derive from exhaust pollutants such as CO, NO_x, and HC's causing headaches, nausea, and dizziness and inducing poor hand-eye coordination that may increase the likelihood of a collision [5,6].

Further, in a confined environment, our natural breathing process too can compound these effects and aggravate the health hazard. In the course of breathing, we exhale CO₂, which can displace O₂ in an indoor environment such as a vehicle cabin, leaving the environment O₂ deficient. Such high CO₂ and low O₂ concentrations can cause adverse human health effects. This situation is amplified when vehicle occupants choose to operate the HVAC system in the "closed/recycle" mode aiming to prevent outdoor-polluted air from entering. Various independent studies [2–4] have also shown that through this process, the concentrations of O₂ and CO₂ may come to exceed safety limits set by OSHA. Interestingly, a study on fatal single vehicle crashes highlights that the vehicle is more likely to have closed windows and a heater on, than to have fresh air and air conditioning fitted [7]. An O₂ deficient environment has been termed "hazardous" by OSHA when the O₂ concentration is less than 19.5% [8]. Low O₂ levels can impair judgment, increase heart rate and impair muscular coordination.

Another overlooked issue concerning vehicle cabin air quality are motor vehicle exhaust gas suicides caused by CO poisoning [9–12]. Of the 2,320 suicides registered for the year 2002 in Australia, statistics indicate that 416 persons (18%) died from motor vehicle exhaust gas [13]. Many deaths are also attributed to unintentional CO poisoning in and around motor vehicles. A study of U.S. deaths found that 57% of unintentional CO poisoning deaths occurred in automobiles [14].

In recent years, new innovative sensors, systems and after-market products have been introduced in an attempt to alleviate vehicle cabin air quality concerns. The sensors and systems that achieve this will be the focus of this chapter.

2. VEHICLE CABIN AIR QUALITY MONITORING (AQM)

To summarize, vehicle cabins air quality concerns are usually generated by the following four scenarios:

1. Pollutant gases entering the vehicle via the ventilation system.
2. A lack of fresh airflow resulting in low O₂ and high CO₂ concentrations due to occupant breathing process.
3. Pollutant gases entering from the external environment via window openings, imperfect seals and other holes.
4. Toxic gases entering the vehicle cabin by redirected exhaust fumes for self-harm purposes.

Currently, no system or aftermarket product addresses all four vehicle AQM concerns. Only two commercial AQM solutions currently exist for vehicles; (1) The most common are AQM systems controlling HVAC ventilation flaps and (2) Less common are aftermarket toxic gas alarms for vehicle cabin applications.

Currently, the demand for AQM systems is driven by the increasing concern for passenger safety, health, and comfort, and by automakers aiming for features and attributes that differentiate their vehicles. In turn, this growth has increased demand for reliable automotive air quality sensors.

Figure 1 shows a simplified view of an AQM system controlling the HVAC ventilation flap. External gases enter the vehicle cabins via the ventilation system. Mounted in the air intake of the HVAC system, the AQM sensor sends a signal to the fresh air inlet flap to close when pollutant gases are detected and automatically reopen when the external air quality returns to an acceptable level. Although a driver could close the air inlet manually, forgetting to reopen it could cause the O₂ concentration in the cabin to decrease and CO₂ levels to increase. Therefore, a compromise must be reached. Typically, the AQM system maintains the ventilation flap in the open position. Only when high concentrations of pollutant gases are sensed, is the flap closed. Intelligent algorithms based on the gas concentration rate of change efficiently achieves this, without the need to calibrate the system to absolute gas concentrations. Features offered by AQMs include dynamic adaptation to various driving environments (e.g., city, outback, heavy traffic, underground tunnels), automatic sensor sensitivity control via software to continuously adapt to ambient pollution levels, automatic

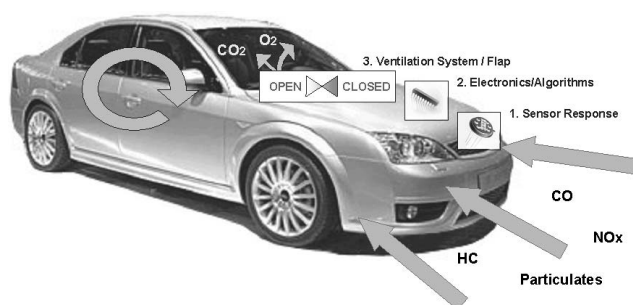

Figure 1. An overview of a typical HVAC AQM system. When the ventilation flap is open, pollutants such as CO and NO_x enter the cabin. When the ventilation flap is closed, high CO₂ and low O₂ concentrations occur which may induce driver fatigue.

compensation for sensor tolerances yielding consistent sensor performance over the life of the vehicle, self-diagnostics, various interface specifications for Pulse Width Modulation (PWM) or bus-compatible applications.

Such integrated AQM systems are effective in improving vehicle air quality, however, the shortfall is that they cannot ensure the vehicle cabin air quality remains within health and safety standards. This is the major disadvantage of current HVAC AQM systems.

3. VEHICLE CABIN AQM GAS SENSORS

At the heart of the AQM system, are the gas sensors. The sensor detects target gases, and then converts the information into an electrical signal for processing. There are numerous ways to sense gas. However, as cost, size and simplicity are critical sensor attributes, only three sensing technologies can be considered for vehicle cabin air quality monitoring:

1. Semiconducting Metal Oxide (SMO) Technology
2. Electrochemical (EC) Technology
3. Infra-Red/Optical Technology

First are common Semiconducting Metal Oxide (SMO) gas sensors. These sensors are heated, causing reducing/oxidizing gases to react with the surface of the metal oxide film and changing the semiconductor's conductivity proportionally to the target gas concentration. Second are electrochemical gas sensors. Electrodes placed in contact with a liquid electrolyte to form an electrochemical sensor. As the gas diffuses it reacts with the working electrode, changing its potential proportional to the gas concentration. And thirdly are IR optical sensors where the optical sensing element undergoes light transmission changes when exposed to the target gas.

Table 1 compares the technologies against seven key AQM criteria. Both metal oxide and optical sensors are good candidates as AQM sensors. Electrochemical sensors on the other hand fall short as they have a maximum lifetime of approximately 2–5 years, rendering them unacceptable for AQM applications. Today, most AQM sensors employ SMO gas sensors. However, as the cost of IR based sensors rapidly decrease, they will more readily be found in integrated and aftermarket AQM solutions.

3.1. Semiconducting Metal Oxide (SMO) Gas Sensors

Semiconducting Metal Oxide (SMO) gas sensors are well suited for vehicle cabins air quality applications since they

Table 1. Comparison of three gas-sensing technologies with respect to vehicle air quality monitoring criteria.

Criteria	Infra Red–Optical	Electrochemical	Metal Oxide
Cost	\$15US	\$10US	\$10US
Life time	>6 years	2–5 years	>6 years
Sensitivity	Very Good	Very Good	Very Good
Selectivity	Excellent	Very Good	Poor
Response time	seconds	seconds	seconds
Size	Medium	Medium	Small
Ease of use	Good	Excellent	Excellent

are small, reliable, durable, and low cost. But traditionally, the major disadvantages of SMO as a gas sensitive material has been their poor gas selectivity and humidity and temperature influence [15, 16]. The introduction of noble metal catalysts, filters (activated carbon), and modification to the SMO microstructure has enabled SMO sensor manufacturers to improve selectivity performance [17, 18]. However, it should be noted that high selectivity is not the most critical requirement for AQM applications. After all, the aim is to prevent pollutant gases as a whole from entering the vehicle cabin (CO, NO₂, HC). As a result, nearly all HVAC AQM systems have exploited the non-selective nature of SMO gas sensors. Instead of developing a single specific gas sensor for each target gas, two sensing elements are used as a complete solution. One sensing element responds to “reducing gases” and the other to “oxidizing gases”. At the surface of the SMO film, oxidizing gas molecules such as NO₂ and O₃ strip an electron from the conduction band, which results in a decrease in film conductivity, such that [19],

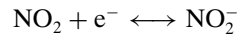

For reducing gases such as CO, molecules react with adsorbed oxygen ions on the surface of the oxide. The adsorbed oxygen loses its electron by reacting with the reducing gas molecule thereby increasing the films conductivity. A simple model consisting of three possible reactions is shown [20, 21]:

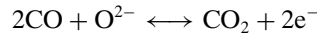
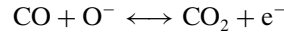
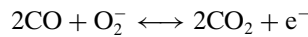

The relationship between film conductivity (σ) and gas concentration (c) follows a power law that can be described by [22]:

$$\sigma = kc^n$$

where k is a measured proportionality constant and n has values between 0.3 and 0.8. The positive sign is used for oxidizing gases, while the negative sign is used for reducing gases. Due to the non-linear nature of the SMO sensor, linearization circuitry within hardware or software is usually required.

For SMO material to react with a gas, the material must be elevated to temperatures above 200 °C, otherwise chemisorption and adsorption would not occur. Elevating the sensor to such a high temperature requires an integrated heater circuit to be fabricated below or adjacent to the sensing element. Due to this high temperature requirement, SMO gas sensors have been known to be power hungry. Traditional SMO sensors fabricated on alumina substrates typically consume above 350 mW. One way of reducing power consumption is by fabricating gas sensors using a thin Si membrane [23–25].

At the forefront of thin Si membrane based SMO gas sensor manufacturing is MicroChemical (MiCS) based in Switzerland [26]. The company employs thin Si SMO gas sensors specifically for vehicle cabin AQM applications. Over the past 6 years, MiCS has focused on developing

highly sensitive, stable, selective and low cost gas sensors. The advantage of manufacturing a gas sensor on a thin Si membrane rather than on a ceramic plate is primarily to reduce power consumption. Since the bulk of the substrate is dramatically reduced, less power is required to maintain an elevated operating temperature on the sensitive layer. Figure 2 shows the basic diagram of a generic Si based sensor structure. A membrane is created via photolithography and chemical etching. The Si membrane provides the necessary support and thermal stress compensation. An insulating layer of SiO₂ is then grown and the sensing electrodes and a heater are then fabricated using several precious metals. The heater increases the film’s temperature above 300 °C. Power consumption of the MiCS heater is about 50 mW, dramatically less than other traditional SMO sensors. Other exotic methods of reducing power consumption of SMO gas sensors is by incorporating Silicon-On-Insulator (SOI) structures [27] or by employing MOSFET technology to modulate the sensor output signal [28].

Depending on the target gases, the sensitive film material used in SMO sensors is either tin oxide (SnO₂), tungsten oxide (WO₃), indium oxide (In₂O₃) or any host of transitional metal oxide, typically fabricated at a thickness between 200 nm and 10 microns [29–33].

For AQM applications, MiCS manufactures dual element sensors for detecting both reducing gases such as CO and HC’s and oxidizing gases such as NO₂ and O₃. This allows for detection of gasoline pollution from cars and motorbikes, and diesel pollution from diesel-powered cars as well as trucks and buses. The Si based sensor chips are bonded to either TO packages or SMD packages as show in Figs. 3 and 4, respectively.

Figure 5 shows the dynamic response of the MiCS reducing gas element exposed to various concentrations of CO.

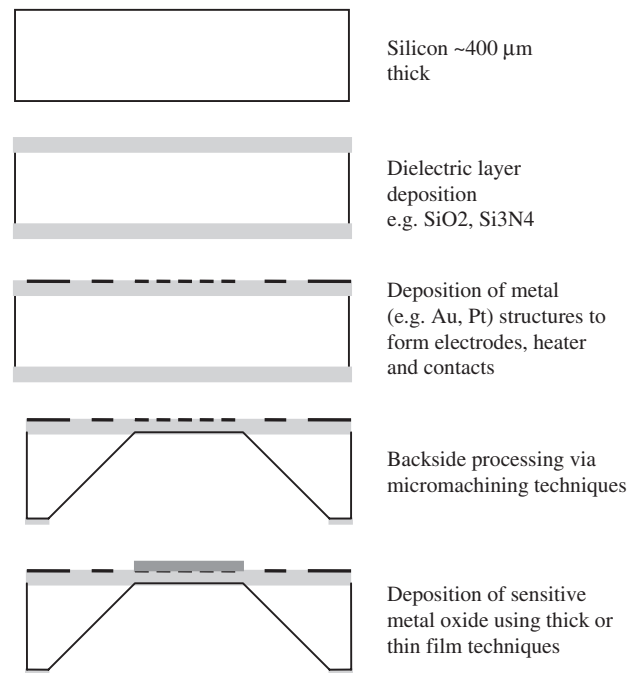

Figure 2. Generic Si membrane metal oxide gas sensor structure.

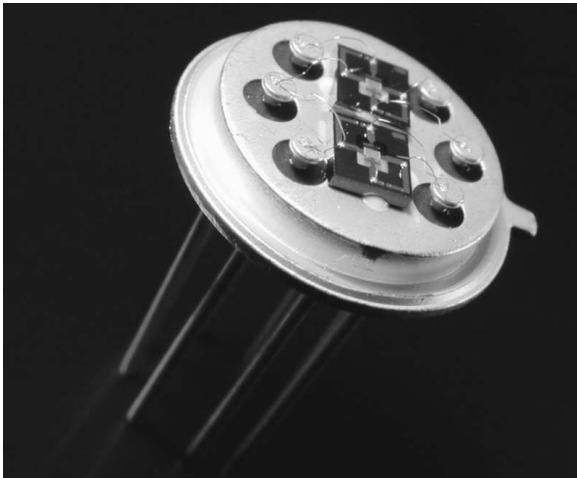

Figure 3. Dual element gas sensor bonded to a TO5 package, current product released in 2004 (Courtesy of MicroChemical, Switzerland).

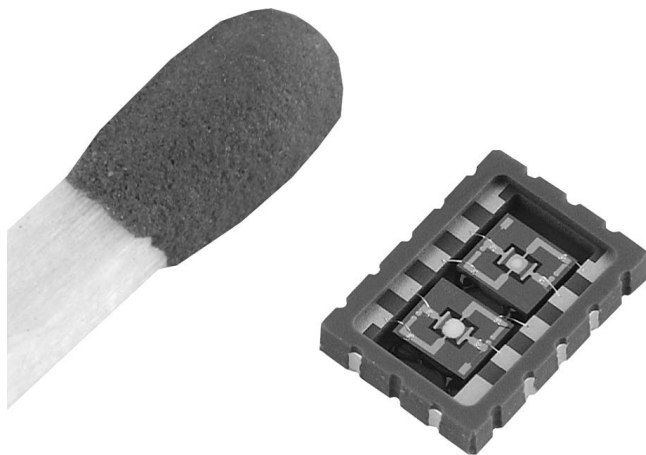

Figure 4. New generation dual element gas sensor in a SMD package, released in 2004 (Courtesy of MicroChemical, Switzerland).

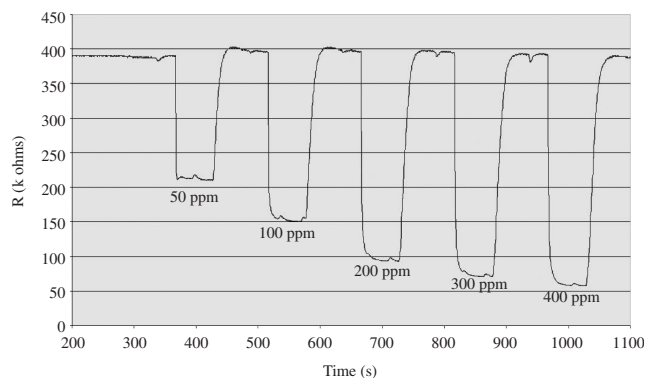

Figure 5. MiCS SMO reducing gas element sensor dynamic response to CO at various concentrations (Courtesy of MicroChemical, Switzerland).

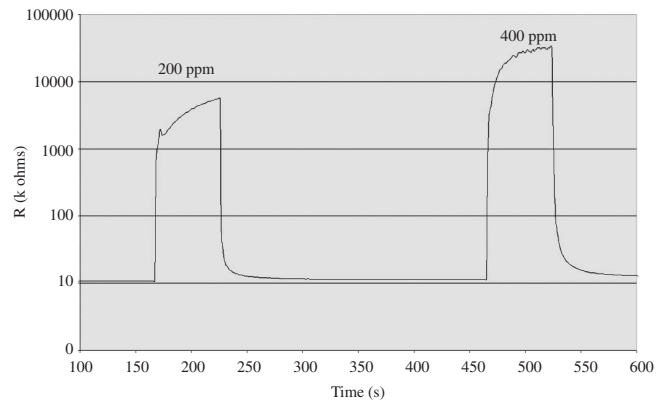

Figure 6. MiCS SMO oxidizing gas element sensor dynamic response to NO₂ at 200 and 400 ppb (Courtesy of MicroChemical, Switzerland).

The x -axis represents time (seconds) and the y -axis represents the sensor element's resistance (kohms). Figure 6 shows the dynamic response of the oxidizing gas element exposed to 200 and 400 ppb of NO₂. Key features of both reducing sensing and oxidizing elements are that the sensors are stable, repeatable and have a response time of seconds.

MiCS has also developed an AQM module that includes its dual AQM gas sensor. As shown in Fig. 7, the module is extremely small and can be seamlessly located within the HVAC to automatically control the ventilation flap. The AQM module maintains the ventilation flap in the open position. The flap is closed only when high concentrations of pollutant gases are detected. Intelligent algorithms based on sensor signal rate of change efficiently achieves this, without the need to calibrate the system to absolute gas concentrations. Figure 8 shows a graph of both oxidizing and reducing gas levels (relative) in a test vehicle while driving through several roadway tunnels. The x -axis represents time (seconds) and the y -axis represents the normalized sensor's electrical output signal. The flap is closed when pollutant levels start to increase and re-opened when pollutant levels are reduced, clearing showing the use of the differential.

Similar to most manufactured automotive components and systems, the supply chain of AQM sensors and systems includes various players. Figure 9 shows an overview of the supply chain of AQM sensors. AQM sensors are sold to electronic module manufacturers, tier one companies and



Figure 7. Photograph of an AQM sensing module (Courtesy of MicroChemical, Switzerland).

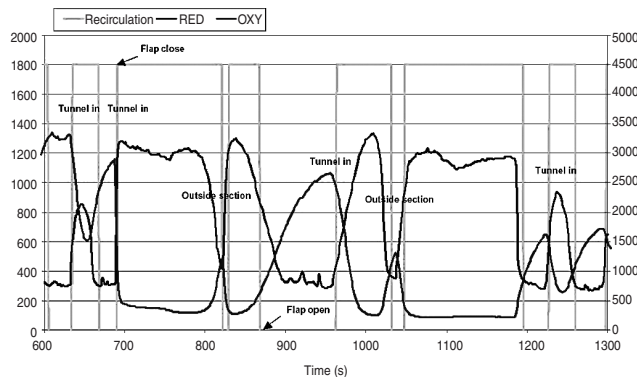

Figure 8. Example of MiCS’ dual element sensor output signal whilst driving through polluted roadway tunnels. Note that the reducing and oxidizing sensor signals are complimentary. The flap is closed when both high reducing and oxidizing gases exist. This translates to a high reducing signal level and a low oxidizing signal level (Courtesy of MicroChemical, Switzerland).

vehicle system (HVAC) manufacturers and then onto vehicle manufacturers. More specifically, MiCS’ AQM sensors are supplied to their partner, SAIA-Burgess Electronics and directly to automotive HVAC suppliers (e.g., Visteon, Delphi, Valeo) and then to automobile manufacturers (e.g., PSA, Renault). A typical price for an AQM sensor module in volume is about \$US10. MiCS is currently experiencing AQM sensor unit growth of 30% per annum. In 2003, MiCS produced more than 600,000 gas sensors and expects to produce more than a million units in 2004.

According to the Sensors Business Digest [34], 2.9 million vehicle cabins air quality units were sold in 2002. At the component level, 50.6 million SnO₂ sensors were sold in 2003. Intechno Consulting [35] projects worldwide sensor demand

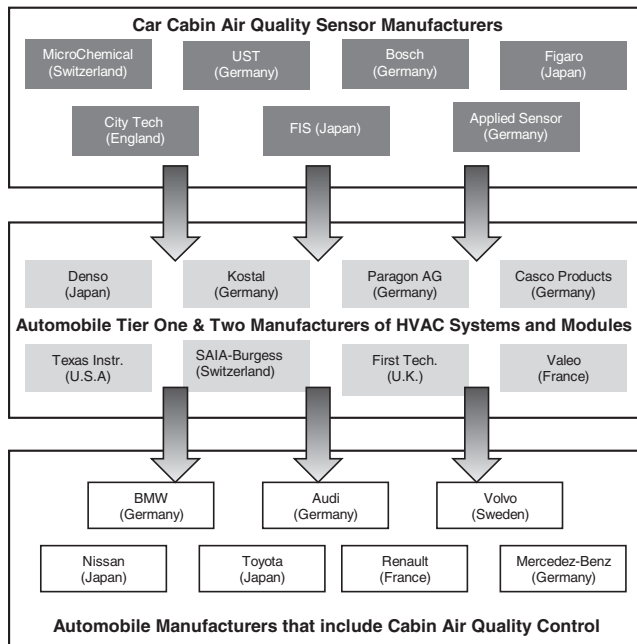

Figure 9. A simplified view of the HVAC AQM sensor supply chain. From sensor to module to system and to vehicle manufacturer.

Table 2. The projected % amount of electronic AQM functionality fitted in passenger vehicles manufactured in different countries [Source: Intechno Consulting (USA)].

	1998	2003	2008
Germany	10%	50%	75%
France	30%	40%	65%
U.K.	10%	50%	75%
Italy	2%	20%	50%
U.S.A.	1%	5%	30%

of chemical gas sensors for convenience electronics to be valued at \$269.1 million by the year 2008. The amount of air quality control electronic systems fitted on HVAC systems in passenger vehicles manufactured in different countries is shown in Table 2.

3.2. AQM with Optical Gas Sensors

3.2.1. Gas Detection by Infra-Red (IR) Absorption

IR based sensors are suited for AQM applications since they are physically small, consume low power, are selective and are rapidly reducing in cost. These sensors are considered as solid state and have a lifetime over 6 years (depends on IR source degradation/failure) with good resolution, a relatively high selectivity and a broad dynamic range [36–40].

IR based gas sensors identify gases by analyzing their unique IR absorption spectra. Most gases (more than one type of atom) can be detected by measuring their absorption at particular frequencies of IR, which correspond to the resonance of the molecular bonding between dissimilar atoms. Figure 10 shows an IR absorption spectrum of some common gases. For example, to detect HC, the wavelength at which the one carbon atom and one hydrogen atom resonate in a hydrocarbon molecule is 3.4 microns. Therefore, the infrared system will be filtered to detect radiation in a bandwidth centered on 3.4 microns.

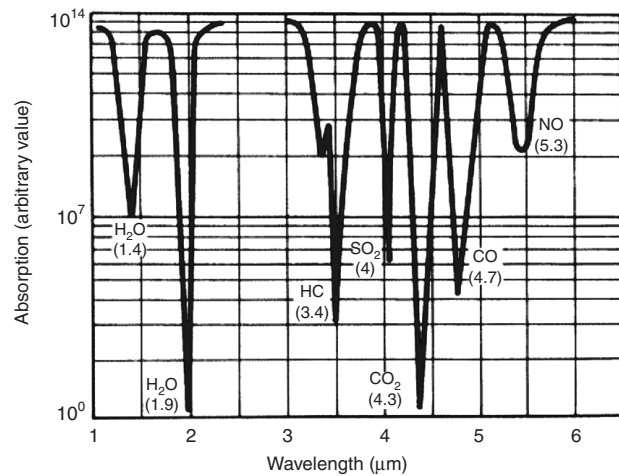

Figure 10. Absorption bands of various gases in the IR region.

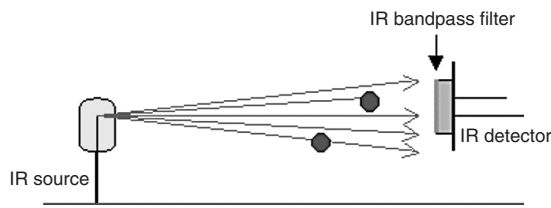

Figure 11. Simplified diagram of a single beam IR absorption gas detector.

There are certain basic components common to all IR gas sensors: an IR source (e.g., incandescent lamp), an IR detector (e.g., thermopiles, pyroelectric detectors, photodiode), a means to select appropriate wavelengths (e.g., band pass interference filter) and a sample cell. The simple sensing setup is shown in Fig. 11. The IR source is at one end and the IR sensor at the other. The band pass optical filter must correspond with the absorption wavelength of the gas being measured. As the concentration of gas being measured increases, the output signal from the sensor reduces as the IR is absorbed by the target gas molecules. The relationship between IR transmission, I , and gas concentration, c , can be explained by the fundamental Beers law of absorption:

$$I = I_0 e^{-kcl}$$

where I is the intensity of IR radiation at the IR detector, I_0 is the IR radiation emitted from the IR source, k is the absorption coefficient, and l is the optical path length.

In a real world application, a simple IR detection setup as shown in Fig. 11 is not sufficient since it is prone to large errors. A reference detector is required to compensate for humidity, vibration, source intensity deterioration, detector contamination, vibration, and aging. As a result, a dual beam topology is typically employed with most IR gas sensors. A reference detector senses IR at a neutral wavelength where almost no absorption takes place (i.e., 4 microns). By taking the ratio of both detector voltage U_1 and reference signal U_2 , the common I_0 coefficient is cancelled, and the target gas signal component remains which corresponds to the target gas concentration as shown in Fig. 12.

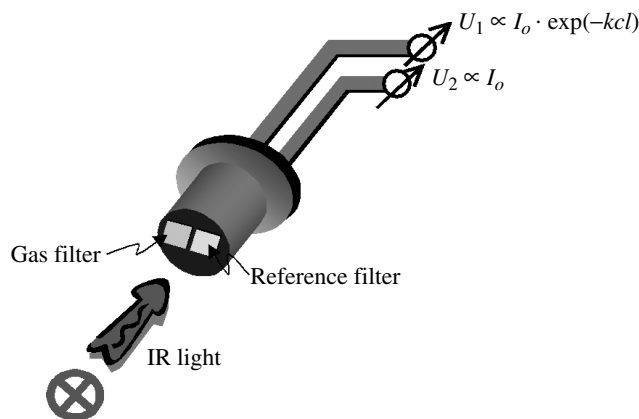

Figure 12. A dual beam arrangement makes the gas detector insensitive to source performance deterioration. (Courtesy of PerkinElmer Optoelectronics, Germany).

3.2.2. Thermopile Based AQM Gas Sensors

Thermopiles are one way of detecting IR and implementing a gas sensor. PerkinElmer Optoelectronics (Germany) [41] offers silicon micromachined thermopiles with bandpass filters for gas sensing applications. The device together with an appropriate IR source is able to provide an adequate AQM solution. The advantage of thermopiles over photonic detectors is their almost constant sensitivity over the IR spectrum [42–44]. Therefore, the thermopile is an excellent detector choice for gas absorption instruments when combined with the proper IR bandpass filter.

A thermopile senses IR through a number of tiny thermoelements placed below an absorber area. The IR that strikes the absorber heats it and generates a voltage that is a direct measure of incident radiation power. Thus, if there is a gas-matched IR bandpass filter in front of the thermopile, the decrease in output voltage is directly related to the amount of IR absorption by the respective gas. The output signal is in the range of several $10 \mu\text{V}$, which requires amplification. The detection speed is from 10 to 40 ms. Adequate electronic amplification can be achieved with an auto-zero, low input bias op-amp amplifier solution (e.g., AD8574).

PerkinElmer Optoelectronics manufactures both dual and quad thermopile sensors. The dual thermopile can sense two IR bands (reference and one selective IR band), while the quad can sense four different IR bands (reference and three selective IR bands). Figure 13 shows a photo of the dual thermopile detector. The two thermopiles can be clearly seen. The brown squares in the middle of each sensor chip are the absorber areas, which collect the IR light to be measured. The small cube near to the lower chip is the thermistor which senses the ambient temperature. The right side shows the detectors covered by a cap holding the two different IR-filters. Figure 14 shows the quad thermopile sensor that houses four thermopile chips in a single TO5 case. The open detector in the left clearly shows the internal aperture, that suppresses any crosstalk between the four channels. The sensor also includes a thermistor to provide an internal temperature reference.

An IR bandpass filter consists of a number of dielectric layers on a substrate. PerkinElmer Optoelectronics usually

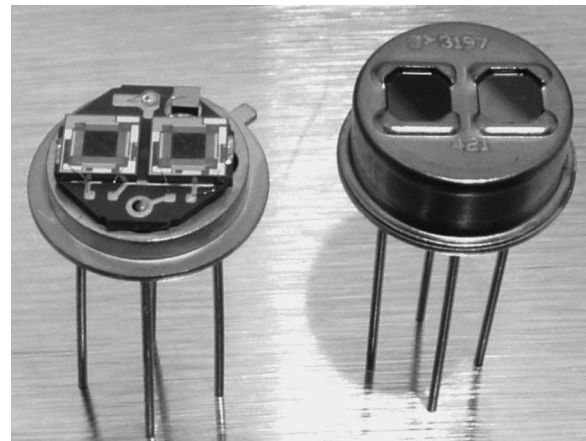

Figure 13. Photo of PerkinElmer Optoelectronics's dual-thermopile detectors (Courtesy of PerkinElmer Optoelectronics, Germany).

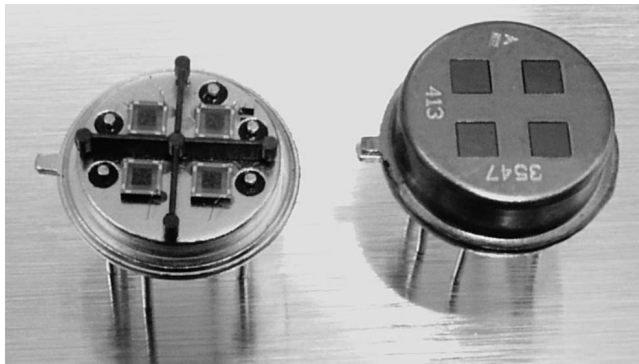

Figure 14. Photo of PerkinElmer Optoelectronics's quad-thermopile detectors (Courtesy of PerkinElmer Optoelectronics, Germany).

employs silicon as substrate material. The thickness and the number of deposited layers on the silicon determine the transmission characteristics of the filter.

Figure 15 shows typical transmittance curves of PerkinElmer Optoelectronics standard bandpass filters. The isolated absorption bands allow the selective sensing of various gases. So, by employing a quad thermopile configuration with CO, NO, and CO₂ filters, an effective total AQM sensing solution is achievable. The CO₂ element is suited to monitor high CO₂ concentrations due to the occupant breathing process especially when the ventilation flap is in the closed position, and the CO and NO elements can monitor pollutants entering the cabin when the ventilation flap is in the open position or when exhaust gas is directed into the cabin for self-harm purposes.

3.2.3. Biomimetic Based AQM Gas Sensors

The Quantum Group (USA) [45] has developed a unique type of solid state IR gas sensor based on the “biomimetic” phenomena. The company has been successful in developing an aftermarket CO detector (COSTAR P-1) for vehicle safety applications based this technology. Figure 16 shows the COSTAR P-1 CO detector designed and developed to alarm when vehicle cabin CO concentrations are high in

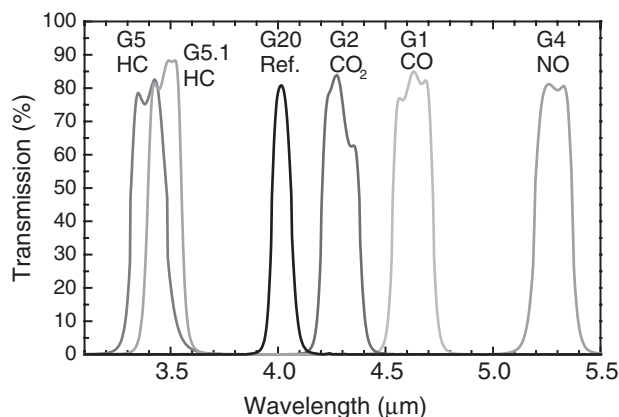

Figure 15. Bandpass characteristics of PerkinElmer Optoelectronics IR gas filters. Filters are identified by a “G” number. The respective matching gas is marked (Courtesy of PerkinElmer Optoelectronics, Germany).



Figure 16. Quantum Groups COSTAR P-1 carbon monoxide detector specifically designed for vehicle cabin CO alarming using a biomimetic IR gas sensor (Courtesy of the Quantum Group, USA).

order to maintain safety, prevent fatigue and alarm occupants of poor cabin air quality within the vehicle cabin.

The IR based “biomimetic” sensors are designed to replicate the CO absorption into blood hemoglobin, hence the name “biomimetic” [46,47]. In doing so, the sensing element can be set to alarm based on the replicated blood level of carboxyhemoglobin (COHB). By replicating the uptake of CO into the human body, a more precise, reliable and accurate CO detection method is conceived.

Figure 17 shows the elements of the biomimetic CO sensor. The patented sensing elements are made from a porous transparent disk coated with a monolayer of supramolecular organometallic complex. This complex is formed via a self-assembly process to generate the sensing elements that mimic hemoglobin. Upon exposure to CO, one or both of the sensing elements changes its spectral character and absorbs photons at a rate dependent on the concentration of CO in the surrounding environment. The sensing elements reverse their spectral shift by a self-generation process whose rate depends upon the decrease of CO in the environment. This mechanism acts as a variable IR band-pass filter. By monitoring the rate of change in the amount of light transmitted through the sensing elements, the concentration of the CO in the surrounding environment can be determined accurately.

The sensing elements are held in optical alignment by the sensor housing placed between an infra-red light emitting diode (LED) and a photodiode. Pulses of light emitted by the LED pass through the first sensor-housing window and are attenuated by the sensing elements. The attenuated light exits through the second sensor-housing window and is then detected by the photodiode. The light transmittance follows Beer’s law.

Figure 18 shows the response, I , of the Quantum Group’s biomimetic sensor towards 100 ppm CO at ambient temperature and relative humidity for 90 minutes. After 90 minutes of exposure to 100 ppm CO, the CO is removed and then the sensor starts regenerating. Upon exposure to CO, the sensor rapidly absorbs photons of 940 nm as reflected by the rapidly decreasing value of I . In a fixed alarm point detector, a value of 30% is typically set as the alarm point. Therefore, in such a detector, the alarm would be triggered

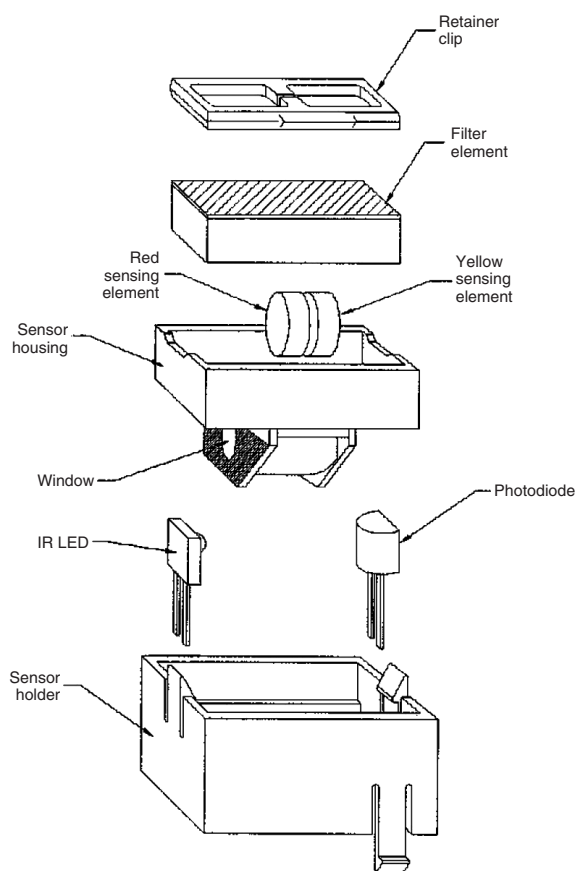

Figure 17. Components and structure of Quantum's biomimetic CO gas sensor (Courtesy of the Quantum Group, USA).

within 40 minutes after exposure, which is well within the UL safety guidelines. When the sensor is exposed to clean air (time = 90 minutes), the CO biomimetic sensor begins an immediate self-regenerating process. As the sensor reverses its spectral shift, the value of I increases and within hours the sensor has fully recovered. The recovery of the sensor best suits a rate of change detection algorithm

The COSTAR P-1 CO detector is designed to alarm before a blood level of 10% carboxyhemoglobin (COHB) is reached, considered as mild exposure. The product is an

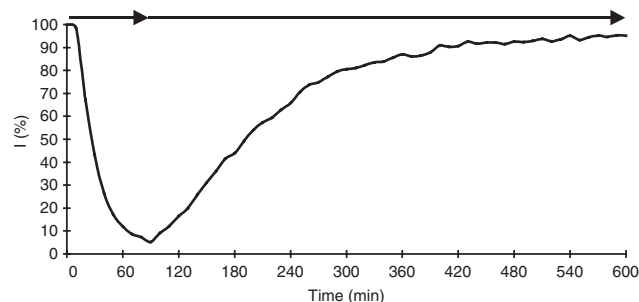

Figure 18. Response (% I) of Quantum biomimetric sensor toward 100 ppm CO at ambient temperature and relative humidity for 90 minutes. After 90 minutes of exposure to 100 ppm CO, the CO is removed and then the sensor starts regenerating (Courtesy of the Quantum Group, USA).

aftermarket standalone CO detector that can be clipped within the vehicle cabin and is powered by a 9 V battery. The detector has very low power consumption in the range of microwatts. Another impressive advantage of the biomimetic sensor technology is that it is highly selective. The Lawrence Berkeley National Laboratory operated by the University of California, have demonstrated that the Quantum biomimetic sensor was unaffected by thirteen interferent gases as compared to metal oxide and electrochemical sensing technologies.

4. FUTURE AQM RESEARCH AND DEVELOPMENT

To some, the future of vehicle cabin air quality will remain an issue given little attention, while others feel an educational effort is required to alert driver of dangers when exposed to poor air quality. The continuation of mass manufacturing of AQM sensors and systems will enhance their scale of economies to reduce price and increase availability. Technological advances will also assist AQM scale of economies by exploring more efficient fabrication methods that may include material and component self-assembly. More specifically, future AQM sensor and system developments can be categorized into three levels:

- (a) material level
- (b) component level
- (c) system level

At the material level, new gas-sensitive materials dependant on nanotechnology and nano-engineering will play an important role. Material nano-structure, electronic properties, optical properties and material morphologies will be controlled to tailor and engineer materials to detect gases at low concentrations in a reliable and repeatable fashion. A good example of such material nano-engineering for gas sensing applications are conductive polymer polyaniline nanofibers developed by the University of California, Los Angeles (UCLA). The nanofibers can be engineered to produce desirable conductivity, surface area (by controlling the diameter and length of the nanowires) and

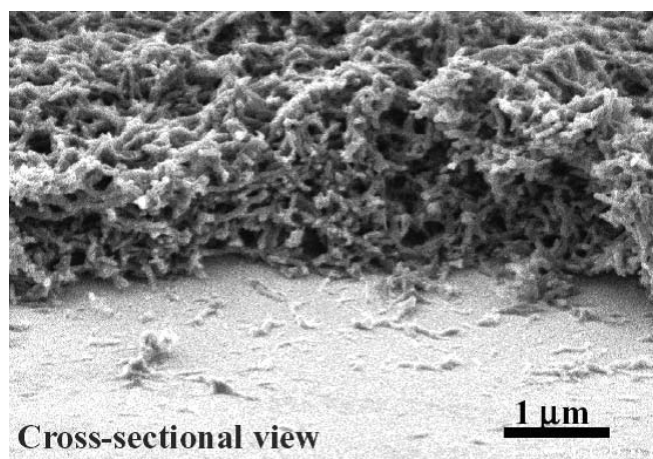

Figure 19. Scanning electron microscopy image shown the cross-section of a nanofiber film deposited on a glass substrate.

material morphology properties [48–51]. Figure 19 shows a SEM of the topology and cross-section of a nanofiber film deposited on glass. The high porosity and surface area makes this material extremely sensitive to gases in the sub-ppm region. The polymer solution is synthesized using standard low cost benchtop methods and is deposited by simple dip or spin coating at room temperature. The nanowires can be modified by loading metal nanoparticles or catalysts according to gas sensing properties required. Although currently polymers lack the required stability and sensor lifetimes required for AQM applications, material nano-engineering has created potential for dramatic improvement. As important, such advances will yield lower-cost AQM gas sensors with faster response times, improved sensitivities and selectivities.

At the component level, Micro-Electro-Mechanical Systems (MEMS) will play an important role. As employed by Microchemical (Switzerland) and PerkinElmer Optoelectronics (Germany), other components employing MEMS fabrication include spectroscopic gas sensors, capable of detecting multiple gases. As an example, The University of California, Davis (USA) and Cornell University (USA) are developing new MEMS Non-Dispersive Infrared (NDIR) spectroscopic gas sensors. The system utilizes a MEMS torsional scanning mirror to scan an infrared beam across a narrow bandpass Linear Variable Filter (LVF) to search for characteristic gas absorption in the wavelength range of 3.0–5.0 μm . Figure 20 shows the schematic of the system setup. The MEMS mirror is bulk micromachined polysilicon with gold coating for better reflectivity [52, 53]. The system is able to be fully integrated onto one Si substrate for a complete system-on-chip. Such highly capable sensors are able to detect a range of gases and provide a complete AQM diagnosis in seconds.

At the system level, the AQM sensors will be seamlessly integrated within automobile management systems with smart hardware and software integration. Such integration will yield an AQM system with more capabilities to cope with various AQM scenarios. Such a fully featured AQM system is consistent with a prototype developed by the Royal Melbourne Institute of Technology University (Australia)

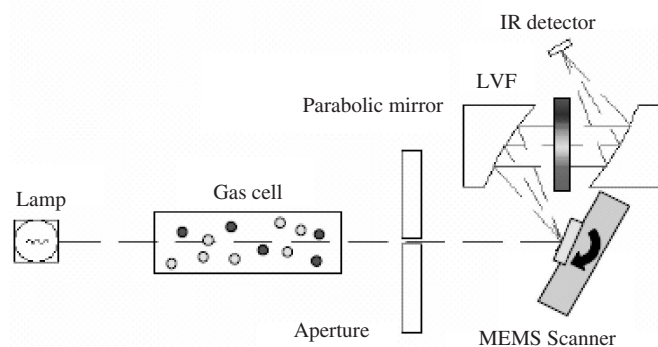

Figure 20. A schematic system setup of a Non-Dispersive Infrared (NDIR) spectroscopic gas sensor utilizing a MEMS torsional scanning mirror to scan an infrared beam across a narrow bandpass Linear Variable Filter (LVF) to search for characteristic gas absorption in the wavelength range of 3.0–5.0 μm .

which is based upon a gas sensor array [1]. In a driver fatigue scenario, the AQM prototype automatically warns of poor cabin air quality and in some instances will automatically shut off the engine during a suicide alarm. The system makes use of smart algorithms based on absolute and rate of change gas concentrations. The group ambitiously aims to provide the Australian government with the necessary test data to consider AQMs to be mandated in all newly sold vehicles.

5. CONCLUSIONS

AQMs will be found in more and more vehicles in the coming years (Table 2). Manufacturers will demand reliable, low cost sensors that will be able to detect sub-ppm gas concentration levels. The systems will become smarter by automatically selecting HVAC ventilation settings and will provide both visual and audible alarm capabilities to prevent driver fatigue. Other safety features such as automatic engine shut-down has the potential to prevent exhaust gas suicides.

Considering the high road fatality statistics directly attributed to fatigue, and the potential safety benefits AQM systems can provide, it is likely that AQM systems may one day find themselves as a standard vehicle safety feature similar to seat belts, air bags and anti skid-brakes. Manufacturers will have to educate consumers on the merits of such systems as the benefits versus incremental cost must be justified.

GLOSSARY

Adsorption The preferential partitioning of substances from the gaseous or liquid phase onto the surface of a solid substrate.

Aftermarket The market for parts and accessories used in the upkeep or enhancement of a previous purchase, as of a car.

AQM An Air Quality Monitor (AQM) is an instrument that detects, senses and monitors various gas components in the air.

Biomimetic Imitating, copying, or learning from biological systems.

Carbon monoxide (CO) An odorless, colorless gas that interferes with the delivery of oxygen in the blood to the rest of the body. It is produced by the incomplete combustion of fuels.

Chemisorption A process whereby a molecule adheres to a surface through the formation of a chemical bond, as opposed to physisorption where that is not the case.

HVAC Stands for Heating Ventilation and Air Conditioning (HVAC) systems are designed with these functions integrated into a single “HVAC” system. Sometimes know as climate control.

Hemoglobin The red respiratory protein of red blood cells that transports oxygen as oxyhemoglobin from the lungs to the tissues, where the oxygen is readily released and the oxyhemoglobin becomes hemoglobin.

Hydrocarbons (HC) Any of numerous organic compounds that contain only carbon and hydrogen.

Infra-Red Range of invisible radiation wavelengths from about 750 nanometers, just longer than red in the visible spectrum, to 1 millimeter, on the border of the microwave region.

Nitrogen Oxides (NO_x) A generic term for the various oxides of nitrogen produced during combustion.

Photolithography A process used in semiconductor device fabrication to transfer a pattern from a photomask to the surface of a wafer or substrate.

Semiconducting Metal Oxide (SMO) Commonly used as a material for gas sensitivity by chemisorption with trace gases in the atmosphere.

Thermopiles A number of thermocouples connected in series. A thermocouple is a junction of dissimilar metals which produce voltage when one side of the junction has a different temperature to the other.

Ventilation Flap Situated within the HVAC system controlling air direction from external or internal (recycle) sources.

Volatile Organic compounds (VOC) Organic chemicals that have a high vapor pressure and easily form vapors at normal temperature and pressure.

ACKNOWLEDGMENTS

The authors kindly thank all contributors including Dr. Mark Goldstein from Quantum Group Inc (USA), Dr. Herve Borrel from MicroChemical (Switzerland), Mr Peter Adrian from the Sensor Magazine (USA), Dr. Jürgen Schilz from PerkinElmer Optoelectronics (Germany). Also thanks go to Dr. David Horsley from University of California, Davis (USA) and Dr. John Provine from Cornell University who are supported by the UC Energy Institute and Prof. Richard Kaner and Dr. Jiaying Huang from University of California, Los Angeles (USA) who are supported by the Microelectronics Advanced Research Corporation, Focus Center Research Program on Functional Engineered Nano Architectonics.

REFERENCES

1. K. Galatsis, W. Wlodarski, B. Wells, and S. McDonald, *SAE Transactions—Journal of Passenger Car—Mechanical Systems* September (2001).
2. S. Sate, *R&D Review of Toyota CRDL* 39(1), 36 (2004).
3. Indoor Climate and Ventilation, Dantec Dynamics, Publication No: 104-102-01 URL: www.dantecdynamics.com.
4. J. Anderson, Transport Ministers Attack Driver Fatigue. Media Release—Australian Commonwealth Department of Transport and Regional Services, December, 1998.
5. E. L. Anderson and R. E. Albert, "Risk Assessment and Indoor Air Quality." CRC Press, Florida, 1999.
6. M. Maroni, B. Seifert, and T. Lindvall, "Indoor Air Quality, Monographs," Vol. 3. Elsevier, Amsterdam, 1995.
7. N. Haworth, P. Vulcan, L. Bowland, and N. Pronk, Report on Estimation of Risk Factors for Fatal Single Vehicle Crashes, Monash University Accident Research Centre, September 1997.
8. Occupational Safety and Health Administration (OSHA), U.S. Department of Labor, Intro to 29 CFR Part 1910.146, Permit-required Confined Spaces.
9. V. H. Routley and J. Ozanne-Smith, *Medical Journal of Australia* 168, 65 (1998).
10. N. Cobb and R.A. Etzel, *JAMA* 266, 659 (1991).
11. C. Morgen, J. Schramm, P. Kofoed, J. Steensberg, and P. Theilade, *Journal of Forensic Sciences* 43, 827 (1998).
12. M. A. Skopek and R. Perkins, *Australian and New Zealand Journal of Psychiatry* 32, 830 (1998).
13. Australian Bureau of Statistics, Motor Vehicle Census, Cat. 0309.0, 2001.
14. US National Center for Health Statistics/National Vital Statistics System, URL: <http://www.cdc.gov/nchs/nvss.htm>.
15. W. Gopel, *Sensors and Actuators B* 18, 1 (1994).
16. N. Yamazoe, *Sensors and Actuators B* 5, 7 (1991).
17. D. Hohl, *Sensors and Actuators B* 1, 158 (1990).
18. G. Sberveglieri, *Sensors and Actuator B* 23, 103 (1995).
19. P. T. Moseley and A. J. Crocker, "Sensors Materials." Institute of Physics Publishing, Bristol and Philadelphia, 1996.
20. S. R. Morrison, in "Semiconductor Sensors" (S. M. Sze, Ed.). J. Wiley, New York, 1994.
21. M. J. Madou and S. R. Morrison, "Chemical Sensing with Solid State Devices." Academic Press, 1989.
22. H. Meixner, J. Gerblinger, and M. Fleischer, *Sensors and Actuators B* 15, 45 (1993).
23. N. Najafi, K. D. Wise, and J. W. Schwank, *IEEE Trans. of Electron Devices* 41, 1770 (1994).
24. J. F. Currie, *Sensors and Actuators B* 59, 235 (1999).
25. I. Simon, *Sensors and Actuators B* 73, 1 (2001).
26. MicroChemical Systems SA, MiCS Homepage, URL: www.microchemical.com, 2004.
27. F. Udrea, *Sensors and Actuators B* 87, 180 (2001).
28. D. Briand, *IEEE Electron Device Letters* 22, 11 (2004).
29. K. Galatsis, L. Cukrov W. Wlodarski, P. McCormick, K. Kalantar-Zadeh, E. Comini, and G. Sberveglieri, *Sensors and Actuators B* 93, 562 (2003).
30. G. Neri, A. Bonavita, S. Galvagno, Y. X. Li, K. Galatsis, and W. Wlodarski, *IEEE Sensors Journal* 3, 195 (2003).
31. Y. X. Li, W. Wlodarski, K. Galatsis, S. H. Moshli, J. Cole, S. Russo, and N. Rockelmann, *Sensors and Actuators B* 83, 160 (2002).
32. K. Galatsis, Y. Li, W. Wlodarski, E. Comini, G. Faglia, and G. Sberveglieri, *Sensors and Actuators B* 77, 472 (2001).
33. K. Galatsis, Y. Li, W. Wlodarski, and K. Kalantar-Zadeh, *Sensors and Actuators B* 77, 478 (2001).
34. Sensor Business Digest, "VIP Sensor and Automation Research Homepage," URL: www.sensauto.com, 2004.
35. Intechno Consulting, ITC Welcome Homepage, URL: www.intechnoconsulting.com, 2004.
36. H. V. Alexandru, C. Berbecaru, F. Stanculescu, L. Pintilie, I. Matei, and M. Lisca, *Sensors and Actuators A: Physical* 113, 387 (2004).
37. S. Eminoglu, D. Sabuncuoglu Tezcan, M. Y. Tanrikulu, and T. Akin, *Sensors and Actuators A: Physical* 109, 102 (2003).
38. D. Bauer, M. Heeger, M. Gebhard, and W. Benecke, *Sensors and Actuators A: Physical* 55, 57 (1996).
39. D. Rossberg, *Sensors and Actuators A: Physical* 54, 793 (1996).
40. C. Cabuz, S. Shoji, K. Fukatsu, E. Cabuz, K. Minami, and M. Esashi, *Sensors and Actuators A: Physical* 43, 92 (1994).
41. PerkinElmer Optoelectronics, PerkinElmer Optoelectronics Homepage, URL: <http://optoelectronics.perkinelmer.com>, 2004.
42. I. H. Choi and K. D. Wise, *IEEE Trans. Electron Devices* 33, 72 (1986).
43. P. M. Sarro, H. Yashiro, A. W. van Herwaarden, and S. Middlehoek, *Sensors and Actuators B* 14, 191 (1988).
44. A. W. van Herwaarden, D. C. van Duyn, B. W. van Oudhesen, and P. M. Sarro, *Sensors and Actuators A* 21, 621 (1989).
45. Quantum Group Inc, Quantum Group Homepage, URL: www.qginc.com, 2004.
46. B. Mizaikoff, R. Göbel, R. Krska, K. Taga, R. Kellner, M. Tacke, and A. Katzir, *Sensors and Actuators B* 29, 58 (1995).
47. M. Jakusch, M. Janotta, B. Mizaikoff, K. Mosbach, and K. Haupt, *Anal. Chem.* 71, 4786 (1999).

48. J. Huang, S. Virji, B. H. Weiller, and R. B. Kaner, *Chem. Eur. J.* 10, 1314 (2004).
49. S. Virji, J. Huang, R. B. Kaner, and B. H. Weiller, *Nano Lett.* 4(3), 591 (2004).
50. J. Huang and R. B. Kaner, *J. Am. Chem. Soc.* 126, 851 (2004).
51. J. Huang, S. Virji, B. H. Weiller, and R. B. Kaner, *J. Am. Chem. Soc.* 125, 314 (2003).
52. D. Horsley, Method of Fabricating Suspended Microstructures, US Patent 6,465,355.
53. D. A. Horsley, N. Wongkomet, R. Horowitz, and A. P. Pisano, *IEEE Trans. Magnetics* 35, 993 (1999).